

PENTHOUSE ENCLOSURE



FITTING KIT

16 x $\varnothing 2.8\text{mm}$ 12MM

2 x

1 x **IMAGE SHOWERS**

Sticker to be added after installation
N.B Guarantee is not valid unless logo sticker is placed on the door.

TOOLS YOU WILL NEED

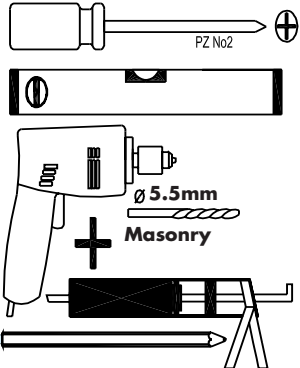

ATTENTION!

PLEASE INSPECT CONTENTS IMMEDIATELY ON RECEIPT FOR ANY DAMAGE CAUSED DURING TRANSIT. ANY CLAIMS MADE LATER CANNOT BE ACCEPTED

BEFORE INSTALLING THE SHOWER TRAY CHECK THAT THE TRAY IS LEVEL AND PROPERLY SEALED AT THE WALL. THE ENCLOSURE WHEN COMPLETED MUST NOT OVERHANG THE OUTSIDE OF THE TRAY. CHECK THE OPERATION OF THE DOOR BEFORE SEALING.

IMAGE SHOWERS ARE DESIGNED TO BE INSTALLED OVER TILING. THE TRAY MUST BE PROPERLY SEALED ALL AROUND THE EDGES WHERE IT MEETS THE TILING AND OR WALLS

LEVEL TRAY AND SEAL

Seal gap under wall profile and around tray

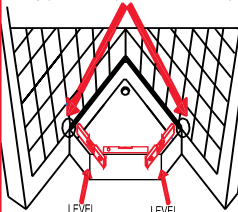

A: Wall Profile fixing

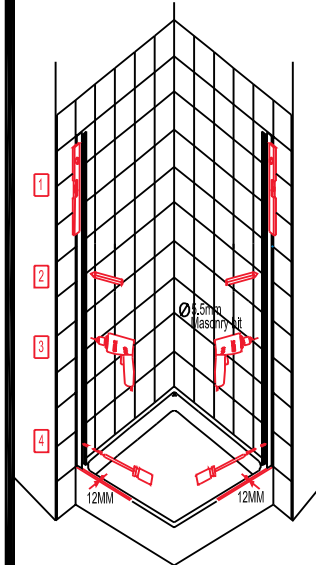

B: Position panels on tray

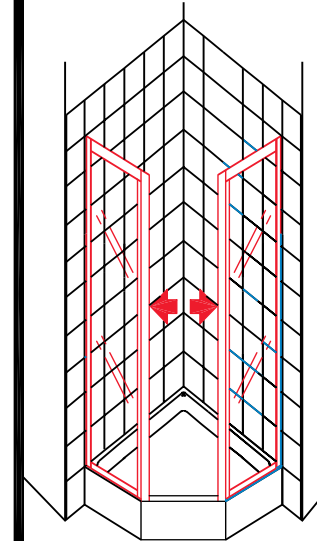

C: Fix side panels to wall profiles

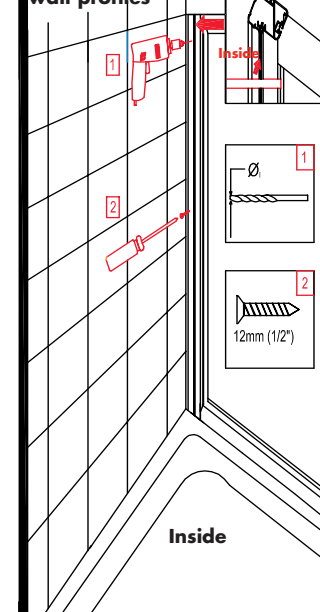

D: Position door and fix

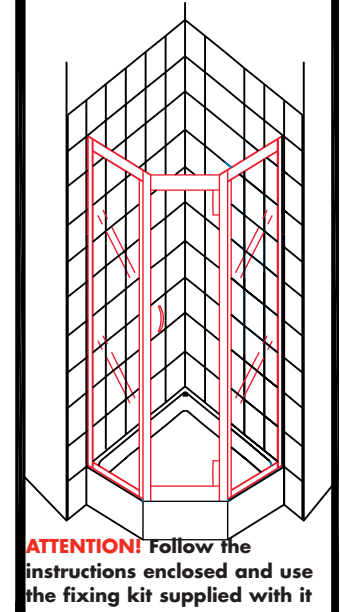

E: Fit support brackets

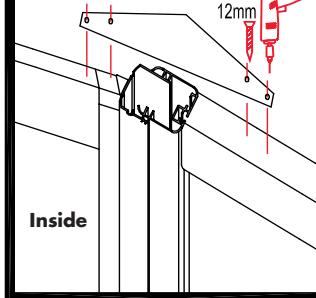

F: Snap on cover strips

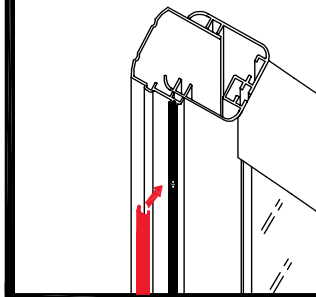

G: Seal Inside

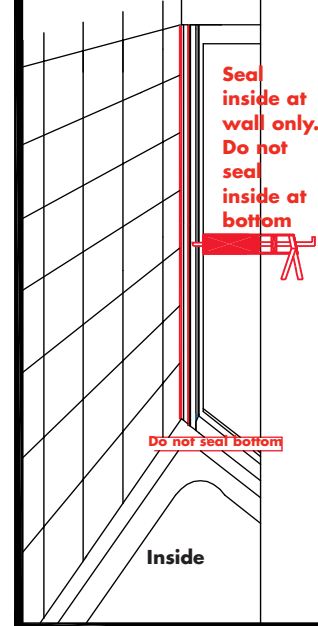

H: Position door and fix

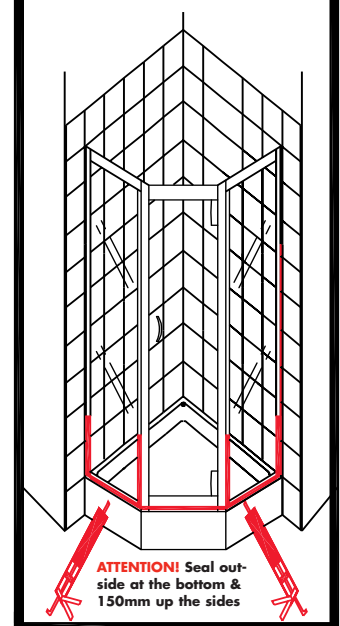

CORNER DOOR

FITTING KIT

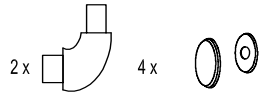
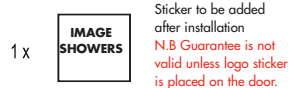
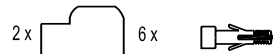

TOOLS YOU WILL NEED

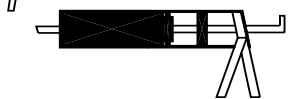
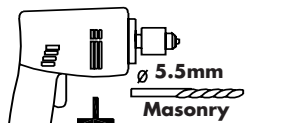
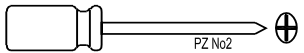

ATTENTION!

PLEASE INSPECT CONTENTS IMMEDIATELY ON RECEIPT FOR ANY DAMAGE CAUSED DURING TRANSIT. ANY CLAIMS MADE LATER CANNOT BE ACCEPTED

BEFORE INSTALLING THE SHOWER DOOR CHECK THAT THE TRAY IS LEVEL AND PROPERLY SEALED AT THE WALL. THE ENCLOSURE WHEN COMPLETED MUST NOT OVERHANG THE OUTSIDE OF THE TRAY. CHECK THE OPERATION OF THE DOOR BEFORE SEALING.

IMAGE SHOWERS ARE DESIGNED TO BE INSTALLED OVER TILING. THE TRAY MUST BE PROPERLY SEALED ALL AROUND THE EDGES WHERE IT MEETS THE TILING AND OR WALLS

LEVEL TRAY AND SEAL

Seal gap under wall profile and around tray

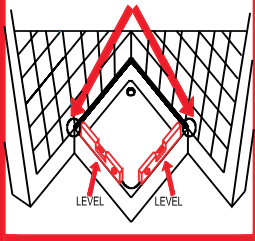

A: Wall Profile fixing

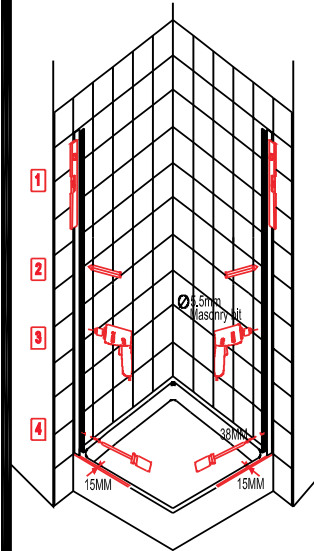

A: Position Door Panels

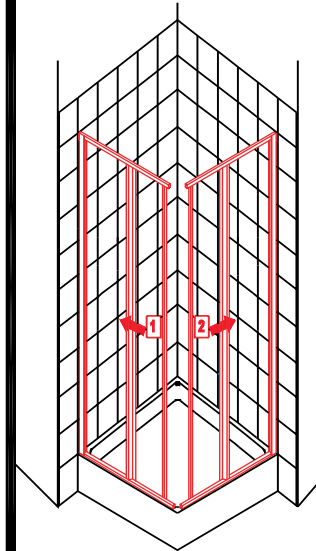

C: Fix Door to profiles

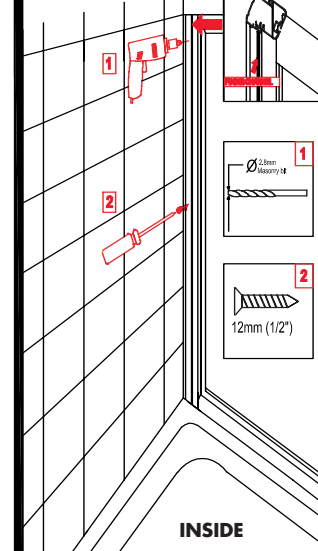

D: Corner Fixing

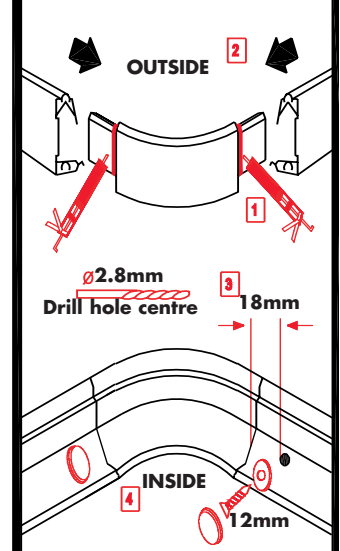

E: Snap on covers

Fit caps as below

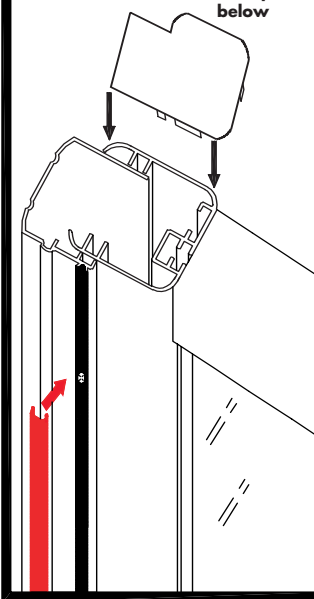

F: Seal Inside

ATTENTION!
Seal inside at the wall only. Do not seal inside at the bottom

DO NOT SEAL BOTTOM

INSIDE

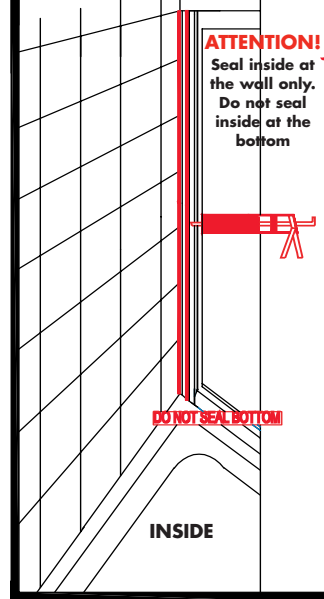

G: Sealing Outside

ATTENTION!

Seal outside at the bottom 150mm up the sides

