

FITTING KIT

- 6 x 10mm
- 6 x 32mm
- 8 x 12mm **CORNER DOOR ONLY**
- 6 x 2.8mm
- 12 x **BIFOLD DOOR ONLY**
- 20 x **CORNER DOOR ONLY**
- 2 x **CORNER DOOR ONLY**
- 1 x **IMAGE SHOWERS** Sticker to be added after installation
N.B Guarantee is not valid unless logo sticker is placed on the door.

TOOLS YOU WILL NEED

- PZ No2
-
- $\varnothing 5.5\text{mm}$ Masonry
-
-

ATTENTION!

PLEASE INSPECT CONTENTS IMMEDIATELY ON RECEIPT FOR ANY DAMAGE CAUSED DURING TRANSIT. ANY CLAIMS MADE LATER CANNOT BE ACCEPTED

BIFOLD DOORS AND SIDE PANELS CAN BE INSTALLED EITHER WAY UP TO FACILITATE LEFT OR RIGHT HAND OPENING

THE ENCLOSURE WHEN COMPLETED MUST NOT OVERHANGE THE EDGES OF THE TRAY

LEVEL TRAY AND SEAL

Seal gap under wall profile and around tray

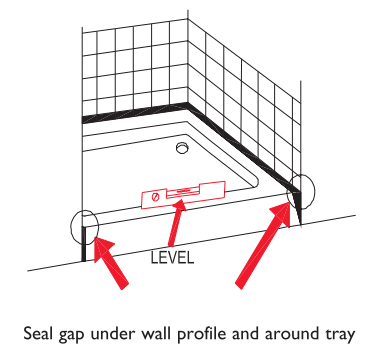
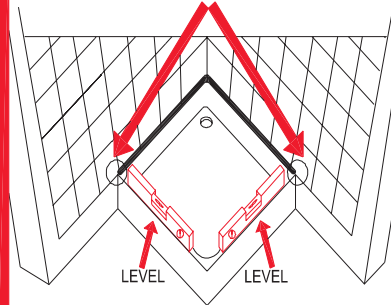

BEFORE INSTALLING YOUR NEW IMAGE SHOWER DOOR PLEASE ENSURE THAT YOUR SHOWER TRAY IS LEVEL AND PROPERLY SEALED

INSTRUCTIONS FOR FITTING DIAMOND OMNI CORNER DOOR

A. Level wall profiles, mark, drill and fix

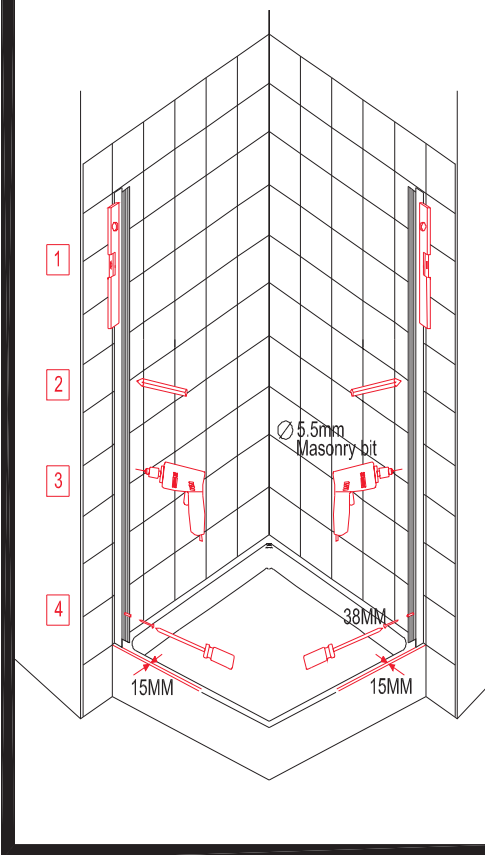

D. Align telescopic extensions

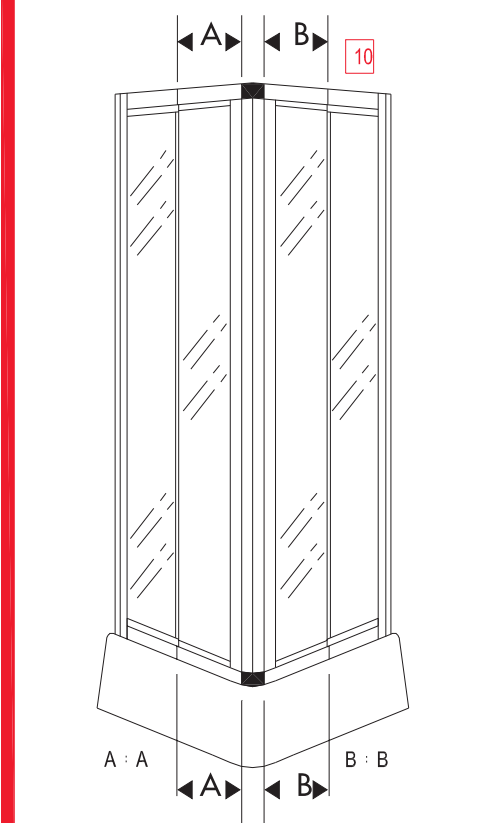

B. Assemble runners & moving panels

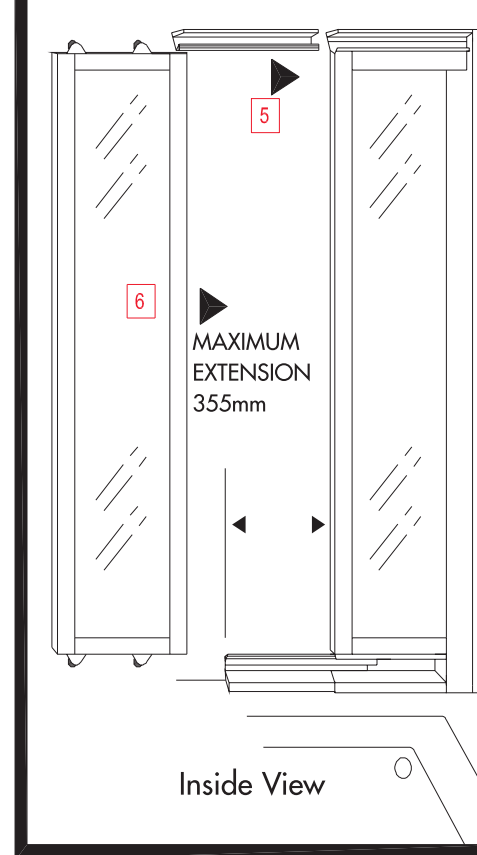

E. Drill & fix panels and extensions

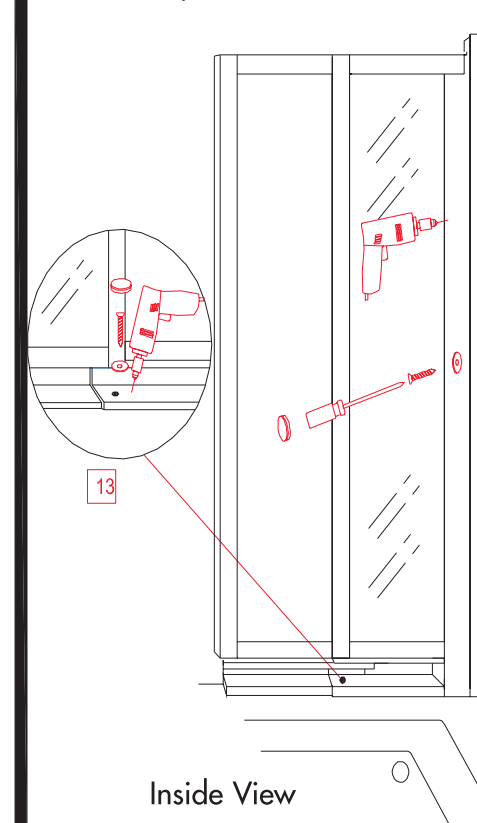

C. Corner joint seal and fix

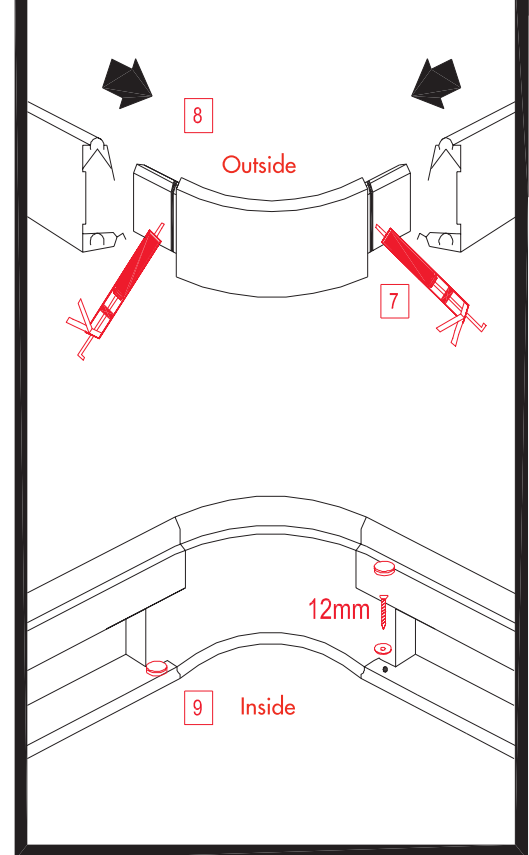

F. Final Sealing

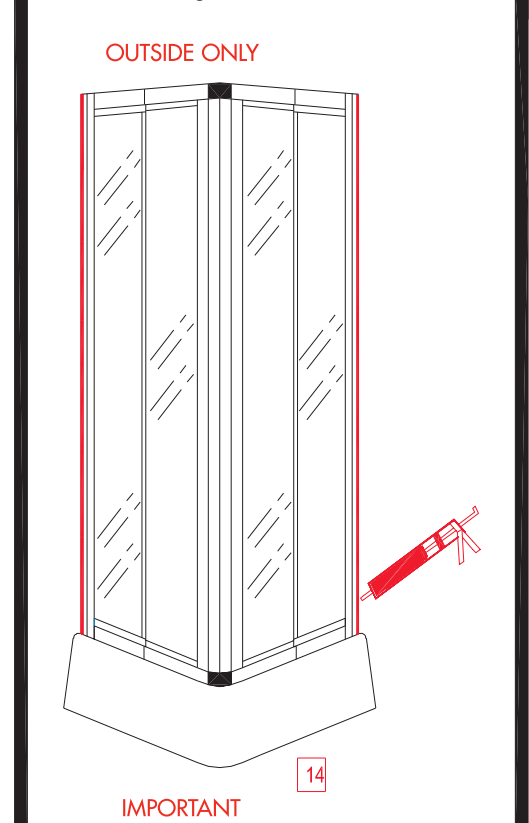

INSTRUCTIONS FOR FITTING DIAMOND BIFOLD, JUMBO & PIVOT DOOR **INSTRUCTIONS FOR FITTING THE DIAMOND SIDE PANELS**

A. Position door in opening

The diamond bifold can be fitted to open left or right by turning from top to bottom.

diamond pivot door must be installed to open outwards

B. Square and Mark

C. Drill and Plug

Ø5.5mm Masonry bit

A: Wall Profiles, Mark Drill and fix

Ø5.5mm Masonry bit

15MM 38MM 15MM

B: Fix panel to wall profile

Fixing Channel

Ø2.8mm Masonry bit

12mm (1/2")

Inside

C: Fit door to side panel profile

D: Fix and Cap

38mm

E: Drill and fix doors to profiles

Ø5.5mm Masonry bit

F: Final Sealing

SEAL OUTSIDE ONLY

D: Snap on cover strips

E: Final Sealing

OUTSIDE ONLY

IMPORTANT